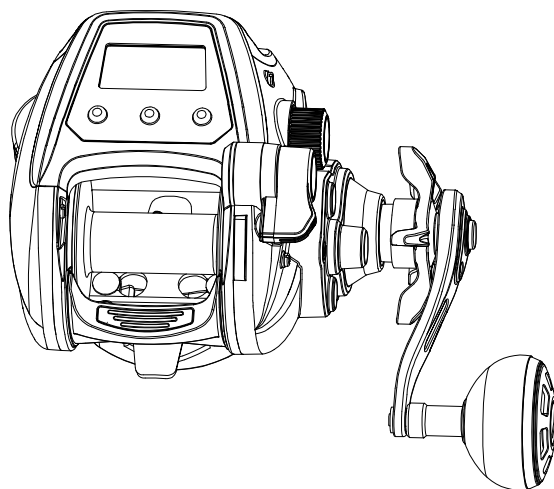


ECODA

EZH 5000 MANUAL

Please read the directions before using
Please keep properly the operation instruction

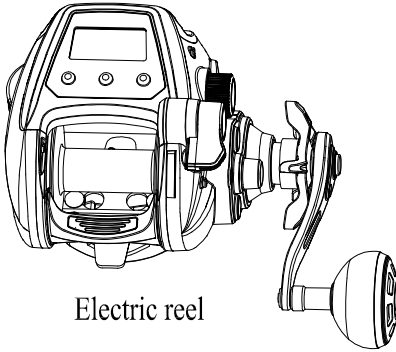




Contents

I. List of Items	1
II. Safety precautions	2
III. Power Supply	3
IV. Maintenance Methods	4
V. Name and Function of Main Parts	6
VI. Digital display screen and key function	7
VII. Connect the power supply	8
VIII. Setting Line Numbers and Winding line	9
IX. View Setup Functions	11
X. Setting the stop position	12
XI. Release and take-up lines	13
XII. Broken line correction function	14
XIII. Initialization	15
XIV. Other Functions	15
XV. Product Parameters	16
XVI. Causes and Solutions of Faults	17
XVII. Explosion view and name	18

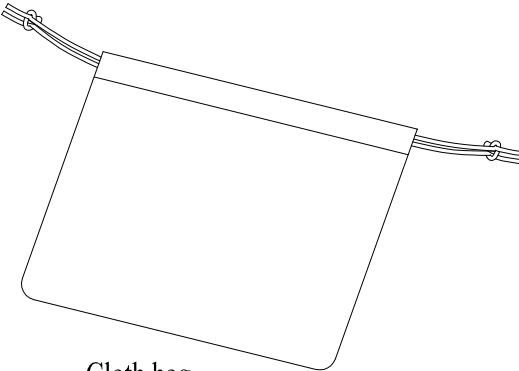
I. List of Items



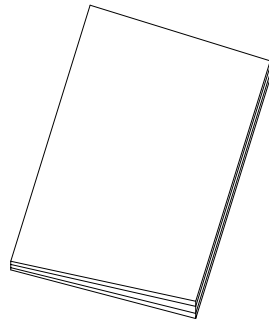
Electric reel



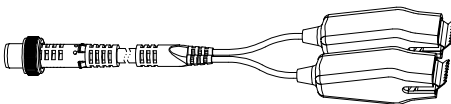
Hook



Cloth bag



Manual and Warranty Card



Power cord



II. Safety Precautions

Precautions for use of electric reels. Please read safety precautions carefully before use to avoid injury.

Warnings

1. Do not put your finger between the line guide and the body, which can easily cause injury;
2. When it is used by children, please make sure children are accompanied by an adult to assist and be careful with hands not to be pinched or smashed in the rotating parts;
3. Keep it out of reach of children.
4. Do not use power sources beyond the specified voltage range, so as not to cause abnormal heating, burns and circuit board faults, etc. Do not plug in household power supply, which may cause short circuit, smoke, fire problems.
5. When using the electric reel, it will produce weak electric waves, which may affect the hearing aid and the medical device implanted in the heart. Especially for those who have heart implants, the heart beats faster and they feel dizzy when using this product. Before using this product, please ask the electronic medical device manufacturer or doctor to confirm that there is no problem before using it.

Warnings

1. After starting the electric reel, please do not touch the moving part to avoid injury.
2. If any water droplets are found in the LCD screen, please stop using it in time and repair it as soon as possible. Failure to do so can result in abnormal operation of the board.
3. If the motor is rotated abnormally during fishing, please unplug the power supply immediately.
4. Before setting the drag power, make sure to adjust the speed control switch to the OFF position so that your hand will not be cut by lines.
5. Do not grasp the fishing line with your hands when paying off or winding up the line, so as not to cut your hands.
6. When maintaining the electric reel, make sure that the power supply is switched off and the power cord is unplugged to avoid damage.
7. When plugging in the power supply on the ship, there will inevitably be seawater and other attachments on the plug. Please wipe clean with a clean cloth and then use it again.
8. When the bottom line is stuck, do not twitch the fishing rod. Wear gloves or wrap a towel around your hand and pull it off. If you can't break it by hand with a thick line, please discuss the safety measures with the captain.
9. Before plugging in the power supply, make sure that the star drag is relaxed. To prevent the motor idling due to circuit board fault, causing unnecessary damage
10. Electric reels shall not be used except for fishing.
11. Do not touch the surface of painting or electroplating in case of peeling, so as to avoid damage.
12. If there is abnormal smell of burning, stop using and remove the power supply to avoid causing heat or fire.
13. There is lubricating oil in the rotating part of the electric reel. Please take care not to stain it on the clothes.
14. Do not disassemble or transform the electric reel, so as not to affect the performance and cause failure.
15. Do not remould the power cord to avoid short-circuit failure and smoke, fire and so on.
16. Please do not hit or press the electric reel with heavy weight, so as not to cause water inflow due to the damage of the panel and cause circuit board failure.
17. Do not place it near the heater to avoid failure due to deformation of plastic parts.
18. If the electric reel is not used for a long time, please put it in the ventilated place first, and then put it away after it is completely air-dried; Loosen the star drag completely.
19. Do not touch the gap in the electric reel with any metal products to avoid failure.
20. Rinse the fishing line thoroughly with tap water before storage and air dry it in a cool place to avoid corrosion of the fishing line due to seawater.
21. Make sure to check the electric reel before going to sea to prevent the electric reel from not working properly after going to sea.

III. Power supply

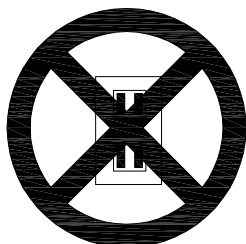
1. About power supply

The rated voltage of this electric reel is DC 12V (other power sources such as household AC 220/110V, DC 24V on board, etc. cannot be used)

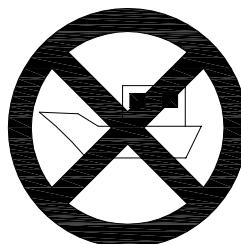
When using a battery with a small voltage, the function of the electric reel cannot be fully realized.

If the ship's generator power supply is used, sometimes the protection circuit of the electric reel may be started due to unstable voltage, which may stop working. Please use a DC power supply of the specified voltage.

220/110V



24V



Be sure to check the battery before depart



1. The battery may discharged spontaneously after being placed on hold for a period of time.
2. Must be fully charged before fishing. Due to the different power supply and plugs of the ship, sometimes it may not be used. Please be sure to check it in advance.
3. If the connector is rusted or corroded, which will cause it not to start normally, please use it after rust removal.

IV. Maintenance Methods

I. Maintenance of electric reels

This electric reel can be cleaned with water. After fishing, remove dirt from all parts of it.

Maintenance method:

1. Clean the electric reel with neutral detergent and soft sponge (Figure 4-1-1).

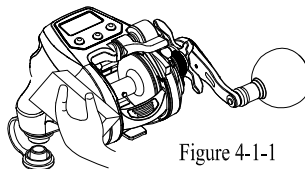


Figure 4-1-1

2. Rinse the detergent with tap water, especially on fishing lines (Figure 4-1-2).

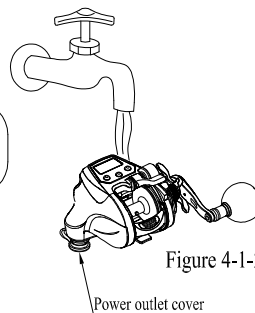


Figure 4-1-2



Note

When cleaning the electric reel, please cover the power socket cover to prevent the power socket from being corroded by water.

3. Dry in a cool place (Figure 4-1-3)

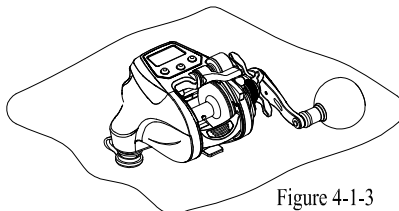
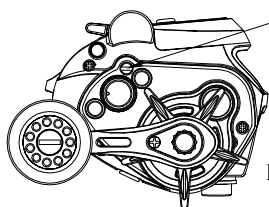


Figure 4-1-3

4. If lubricating oil is needed, add it to the oil filling hole (Figure 4-1-4).



After unscrewing the oil filling hole screws, fill the oil filling hole with lubricating oil

Figure 4-1-4



Figure 4-1-5



Attention

1. It is forbidden to clean the electric reel with seawater or soak it into seawater.
2. Cleaning with gasoline, rosin oil and other organic solvents is prohibited.
3. It is prohibited to soak the electric reel into water for a long time (Figure 4-1-5).
4. Do not use toothbrushes, brushes and steel brushes for cleaning, which may cause scratches on the body of the electric reel.
5. Please grease the power socket after maintenance.
6. When filling, grease may spill out. Be careful of splashing grease on your eyes and clothes.

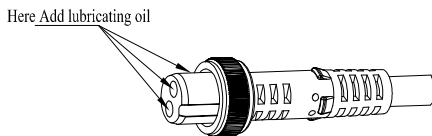
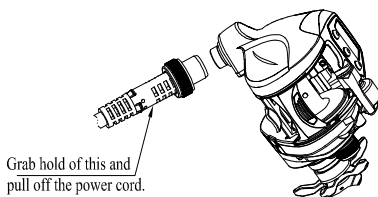
II. Maintenance of power cord

1. In order to prevent power line breakage and other faults, please observe the following precautions:

<p>Prohibition of lifting the reel with power cord</p>	<p>Do not flush the power cord with water</p>	<p>Do not place heavy objects on the power cord or tie the cord</p>	<p>It is prohibited to plug the power cord into the electric reel and wind it around the electric reel</p>

2. Maintenance method of power cord:

- 1) After use, wipe the dirt on the cord with a soft cloth towel dipped with tap water or warm water, and make sure there is no damage.
- 2) After drying, please fill the joint with lubricating oil.
- 3) After the power cord is removed from the electric reel, please keep it properly.



3. Other matters needing attention in maintenance:

1. There are many electronic components, motors, gears and other precision parts in the electric reel. Please do not disassemble them at will. If maintenance is required, please go to the maintenance center or return to the manufacturer.
2. In order to protect the power socket, cover the power socket when the electric reel is not used.
3. Damages of the power cord may lead to line breakage and short circuit. Please replace it in time once it is being found.

V. Name and Function of Main Parts

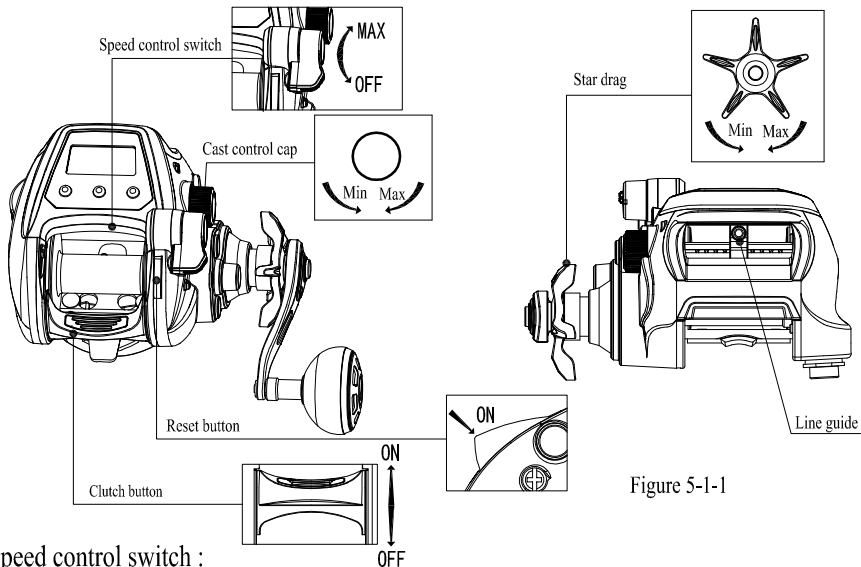


Figure 5-1-1

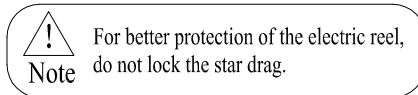
1. Speed control switch :

The adjustable speed switch can freely control that reel speed of the winding line.

- 1) Starting from the OFF position (as shown above), push the speed control switch forward to the MAX position and gradually increase the take-up speed from 0 to the maximum speed;
Returns to the OFF position with a gradual slowdown to 0: When the speed control switch is set to the OFF and MAX positions, there is a warning tone.
- 2) The speed control switch must be turned from the OFF position to start the electric reel. If not, firstly please turn it to the OFF position to start .
- 3) When in the state of self-inspection, protection and winding, 5 meters less than the standard line capacity and the number of winding meters is less than 3meters, the speed control switch cannot start the electric reel.

2. Star drag

Adjust the drag of the fishing reel by adjusting the star drag. Under the normal use condition, the drag of fishing reel should be adjusted before fishing. When slipping the fish, in order to deal with the spool rotation speed is too fast, to prevent clear spool, you can properly adjust the star drag.



3. Cast control cap

By adjusting the cast control cap can prevent the spool rotation speed too fast when paying off, resulting in the line burst.

4. Clutch lever

Press the clutch button, the spool can be freely rotated, at this time in the line-out state. After releasing, turn the handle, and the clutch key will spring up and be in the line-in state. .

5. Reset

When the clutch key is in the OFF position, the RESET pops up; When the reset button is pressed, the clutch button is in the ON position.

6. Line guide

The line guide uniformly aligns the fishing lines on the spool.

VI. Digital Display Screen and Key Function

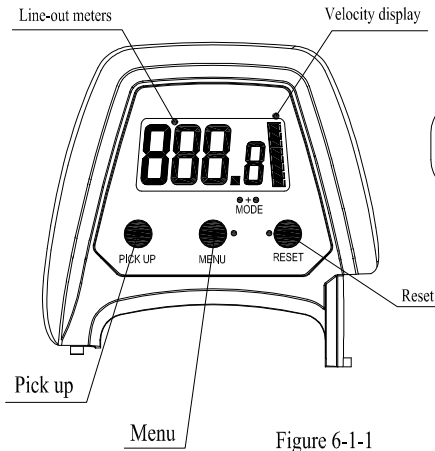


Figure 6-1-1



Note

That every time you complete an operation, there is a warning tone.

1. PICK UP

- 1) Press the "PICK UP key" in the state of winding, releasing and transferring line, to start the fishing reel instantaneously.
- 2) When the "PICK UP key" starts the fishing reel, it runs at the maximum rotation speed.
- 3) Press the "PICK UP key" to stop when winding with the speed control switch.

2. MENU

- 1) When releasing the line, pressing the "MENU" for 2 seconds will cause the signal of setting line number appeared.
- 2) In the winding state, pressing the MENU "will appears different functions or line numbers."

3. RESET

- 1) When releasing, pressing RESET for 2 seconds displays "0.0" in meters.
- 2) When confirming the function, press RESET to confirm the selected function.
- 3) When correcting line breakage, press RESET to correct winding line meters.

4. Speed display

The speed display pattern shows the speed of the electric reel rotation, a total of 8 speed, the more speed display grid, the faster speed of the fishing reel.

5. Releasing meters

The number of meters is the length of the fishing line, which can also be expressed as the depth of the water if the line is set at zero point at sea level.

VII. Connect the Power Supply

1. Connect the power supply

1. The red clip of the power cord is clamped at the positive electrode (+) of the power supply, and the black clip is clamped at the negative electrode (-) (Figure 7-1-1).

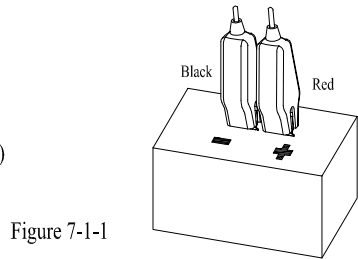


Figure 7-1-1

2. Insert the other end of the power cord into the electric reel socket and lock it with nuts (Figure 7-1-2).
Slot alignment, nut locking

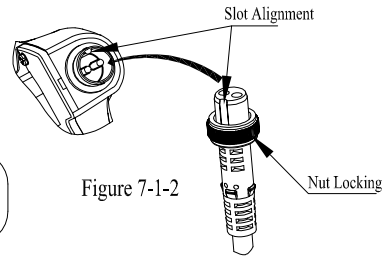


Figure 7-1-2



Note

That the reverse connection of the positive and negative electrodes of the power cord will start the protection function and the electric reel cannot be started.

3. Insert the lithium battery directly into the electric reel socket and lock it with nuts (Figure 7-1-3).

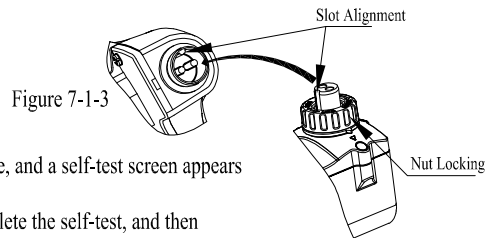


Figure 7-1-3

II. Power on self-inspection

When the power supply is turned on, there will be a warning tone, and a self-test screen appears at the same time.

All the numbers on the screen are converted from 8 to 0 to complete the self-test, and then the screen automatically changes to the line-out state (Figure 7-2-1).



Figure 7-2-1



Note

That no operation is valid during the self-test time after power-on.

III. Warning voltage

1. When the voltage is higher than 17.8 V, the letters of E24 appears on the screen, reminding the wrong voltage (Figure 7-3-1).
2. When the speed pattern flashes, it indicates that the battery capacity is insufficient (Figure 7-3-2);
3. When the starting point and the ending point of the speed pattern flicker, the motor can not work normally and the battery needs to be replaced (Figure 7-3-3).

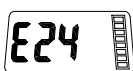


Figure 7-3-1



Figure 7-3-2



Figure 7-3-3

VIII. Setting Line Numbers and Winding line

I. Line binding

Pass the fishing line through the line guide and tie it to the line clip on the spool (Figure 8-1-1).



Note

1. When threading, do not tie a knot .
2. Threading can be made easier by means of a pull hook.
3. When winding the fishing line, the drag shall be set to 1kg.

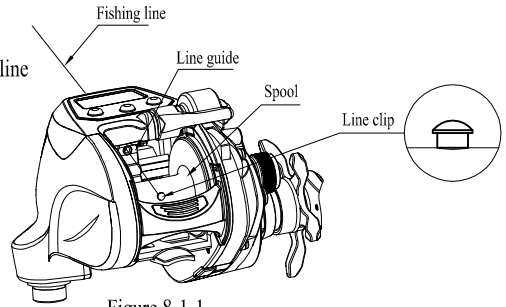


Figure 8-1-1

II. Setting the line number and winding the line

1. Press "RESET" and "MENU" at the same time to enter into the setting function (Figure 8-2-1).

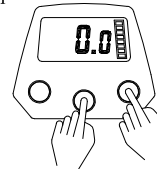


Figure 8-2-1

2. Press "MENU" in turn, a cycle of "PE", "CS", "SL" appears (Figure 8-2-2).

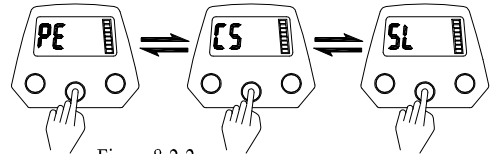


Figure 8-2-2



Note

That "PE" represents the PE line;
 "CS" is used only by the manufacturer;
 "SL" shows the automatic stop position when winding lines.

3. After selecting "PE", press "RESET" and the line number will appear on the screen (Figure 8-2-3).

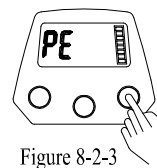


Figure 8-2-3

4. Each time the "MENU" is pressed to change a line number, "PE4", "PE5", "PE6", "PE8" and the standard line capacity of selected are cycled appears (Figure 8-2-4).

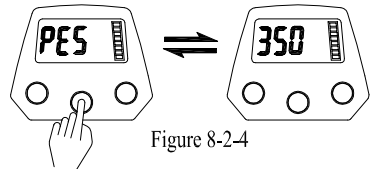
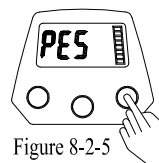
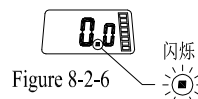


Figure 8-2-4

5. After selecting the line number, press "RESET" to confirm that the screen appears 0.0 and enters the winding state (Figure 8-2-5).

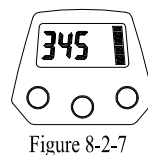


6. Open the speed control switch and start winding (Figure 8-2-6).



7. When the winding with the speed control switch, the winding amount is 5 meters less than the standard, the motor stops automatically, and the winding can be continued to reach to the standard winding amount by press " PICK UP" key or by hand;

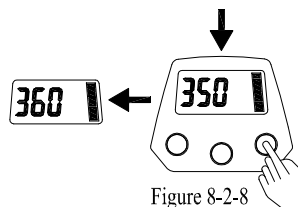
If exceeds the standard winding amount, the winding can be continued manually or by PICK UP key, but there will be an error in the number of meters of releasing lines.



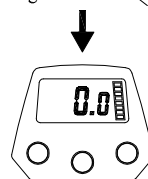
1. During winding, motor rotation will cause external overheating. Please do not touch. At this time, please put the wet towel to the outside hot part before operation.
2. Please use the line number provided by this product, otherwise it will cause error.
3. The line capacity is best according to the reference parameter. If the line is wrapped too much, it will cause friction between the fishing line and the body.
4. The test fishing line used for this product is YGK of Japan.



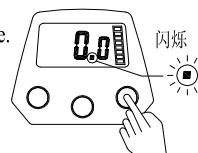
Note



8. When line winding is complete. Press RESET to finish the setting and enter the line out state. The last setting is invalid (Figure 8-2-8).



9. When "0.0" is in the winding state, press "RESET" to finish setting and enter the line-out state. Continue with the last settings of the line number and meters (Figure 8-2-9).



IX. View Setup Functions

1. When in line out state, pressing the MENU key for 2 seconds will appear the set line number (Figure 9-1-1).

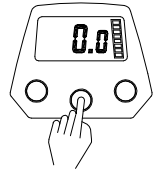


Figure 9-1-1

2. Press RESET to display the set meters (Figure 9-2-1).

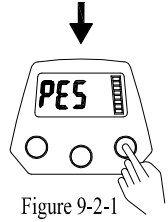


Figure 9-2-1

3. Press RESET again to return to the line-out state (Figure 9-3-1, Figure 9-3-2)

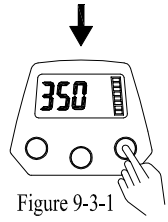


Figure 9-3-1

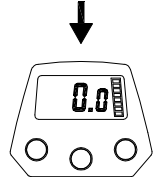


Figure 9-3-2



X. Setting the stop position

- 1、 Press "RESET" and "MENU" at the same time in the state to enter the setting function (Figure 10-1-1).

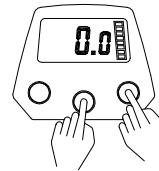


Figure 10-1-1

- 2、 Press "MENU" in turn, and "PE", "CS" and "SL" continue to loop (Figure 10-1-2).

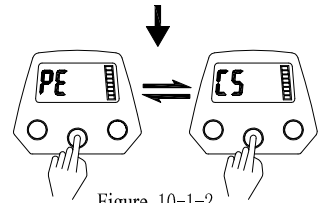


Figure 10-1-2

- 3、 Selecting "SL", then to press the "Reset" button to confirm, and "SL3" will appears on the screen (Figure 10-1-3).

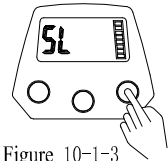


Figure 10-1-3

- 4、 Press "MENU" in turn, and "SL3" and "SL1" will continue to loop on the screen (Figure 10-1-4).

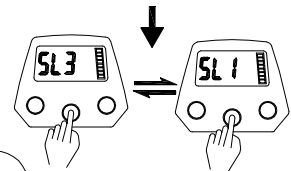


Figure 10-1-4

- ! "SL3" stands that in the line-in state, it will stop winding line automatically when there is 3 meters left. ;
Note "SL1" stands that in the line-in state ,it will stop winding line automatically when there is 1 meter left.

- 5、 Selecting "SL3" when 3 meters left, press the "RESET" button to back to the line -off condition.

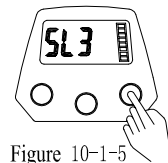
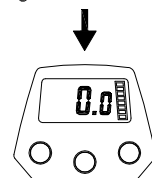


Figure 10-1-5



XI. Release and Take-up Fishing line

1. After the fishing line is tied up with the lead, place the lead at the sea level as the zero point of line-out (Figure 10-1-1). After plugging in the power supply, the screen will display (Figure 10-1-2), and the line-out can be performed at this time.

If the display is not "0.0" after plugging in the power supply (Figure 10-1-3), press "RESET" for 2 seconds, and the screen displays "0.0" (Figure 10-1-4), then you can release the line.

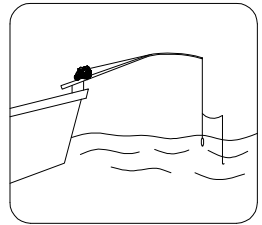


Figure 10-1-1



Note

1. When "-0.0" appears, it means that the meters of the take-up line exceed the meters of the actual releasing.
2. If other positions are selected as zero point to releasing lines, the actual water depth is different from the displayed releasing meters of lines.



Figure 10-1-2



Or

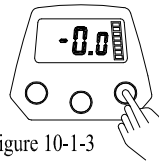


Figure 10-1-3

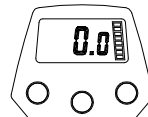


Figure 10-1-4

2. Press the clutch lever button, the reset button bounces (Figure 10-2-1), and fish. Take the water depth of 78 m as an example (Figure 10-2-2).

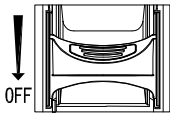


Figure 10-2-1

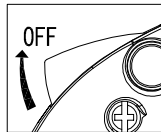


Figure 10-2-2

3. When the release reaches the specified position, turn the handle or press the reset button to reset the clutch lever button (Figure 10-3-1).

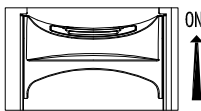
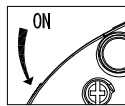


Figure 10-3-1



4. Push the speed control switch from the OFF position to take up the fishing line when the fishing line is rocking. The electric reel is eight-speed transmission, and the appropriate speed can be adjusted according to the actual situation (Figure 10-4-1).

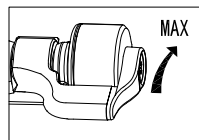


Figure 10-4-1

5. The reel will automatically stop winding when 3 meters left. It can be continue to wind by hand or point motion. If selecting "SL1" from Function 10, it will be automatically stop winding at 1 meter left (Figure 11-5-1).



Figure 10-5-1



1. During line take-up, when the LCD screen displays "7m, 5m, 3m (long ring)", there will be a warning tone.
2. From 5m to 3m, the electric reel decelerates automatically.
- 3 3 meters is the safe position set by the system, and the electric reel stops automatically when reach it.

XII. Correction Function of Breaking Line

1. The original setting is "PE3-300". When the line is broken, retract it, bind the fishing lead, put the line to the zero position, and the digital display shows as Figure 11-1-1.



Please do not wrap the line completely to the spool. Leave a piece of it to avoid any error.

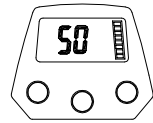
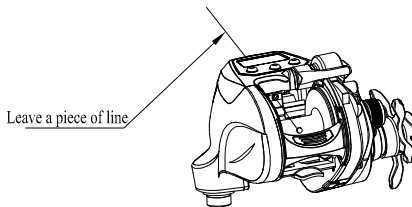


Figure 11-1-1

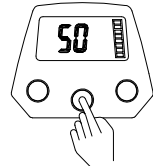


图 11-2-1

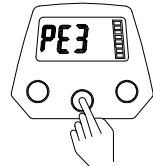


Figure 11-2-2

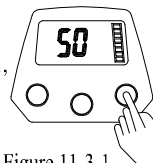


Figure 11-3-1



2. Press the "MENU" for 2 seconds, and the interface will appear as shown in Figure 11-2-2

3. Press the "MENU" again for 2 seconds and the interface appear as shown in Figure 11-3-1, where the number "50" is flashing.

4. Press "RESET" for 2 seconds, and the interface shown in Figure 8-4-1 will appear.
At this time, the broken line correction is completed (Figure 11-4-1).

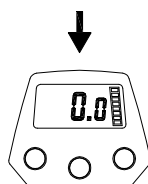



Figure 11-4-1

5. Press Function 9 (View Setup Function) to view the corrected line length (Figure 11-5-1).



图 11-5-1

 **Note** That after correction the reel begin to count with the limitation of maximum 250 meters ,which can ensure the accuracy of take-up and release line.

XIII. Initialization

If the LCD screen is abnormal, first unplug the power: Press and hold "RESET" and then turn on the power, when the self-test screen appears, the program is initialized, the factory settings are restored, the line number and meters set before initialization remain unchanged.

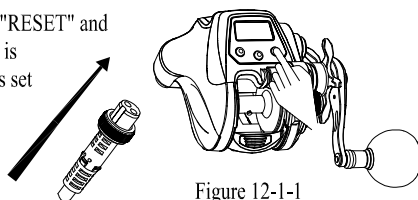


Figure 12-1-1



Figure 12-1-2

XIV. Other Functions

I. Protective functions

1. When the load of the electric reel is too large, the protection function will be started, and the electric reel will stop automatically; "A" appear on that liquid crystal (Figure 13-1-1); Re-opening the speed control switch immediately activates the electric reel.
2. When the motor temperature is too high, start the temperature protection function, and the electric reel will stop automatically. "C" will appear on the liquid crystal (Figure 13-1-2). Only after about 2 minutes can the electric reel be restarted.



Note

1. If the power is cut off for a long time, the LCD screen will be reset.
2. When the electric reel's protection function is started several times, that means the target fish or the lead exceeds the allowable load of the electric reel.
At this time, if continue to use will cause motor and digital abnormal heat, resulting in burn-out.
Please use the electric reel carefully

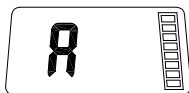


Figure 13-1-1



Figure 13-1-2

II. Memory function

During the operation, the power is suddenly cut off, the power is switched on again within 30 minutes, the state remains unchanged before the power is cut off, and the screen at the time of power cut-off is still displayed on the liquid crystal.

III. Liquid Crystal Panel Lamps

The liquid crystal has an LED lamp on the left and right sides, which turns on the light when it is energized, and can be seen clearly even in the dark or at night;

XV. Product Parameters

Gear Ratio(by hand)	5. 0: 1		
Line Capacity	PE4-500	PE5-350	PE6-300 PE8-220
Self Weight	845g		
Bearings (basic)	12+1		
Maximum static Drag Power	22kg		
Maximum dynamic Drag Power	15kg		
Supply Voltage	DC12-16. 8V		
Current	Maximum current	18A	
	No-load current	2. 5A	
	Rated current	7A	
Winding Speed (1kg)	100m/min		
Depth Range	0-999. 9m		
Operating Temperature	-20---60		

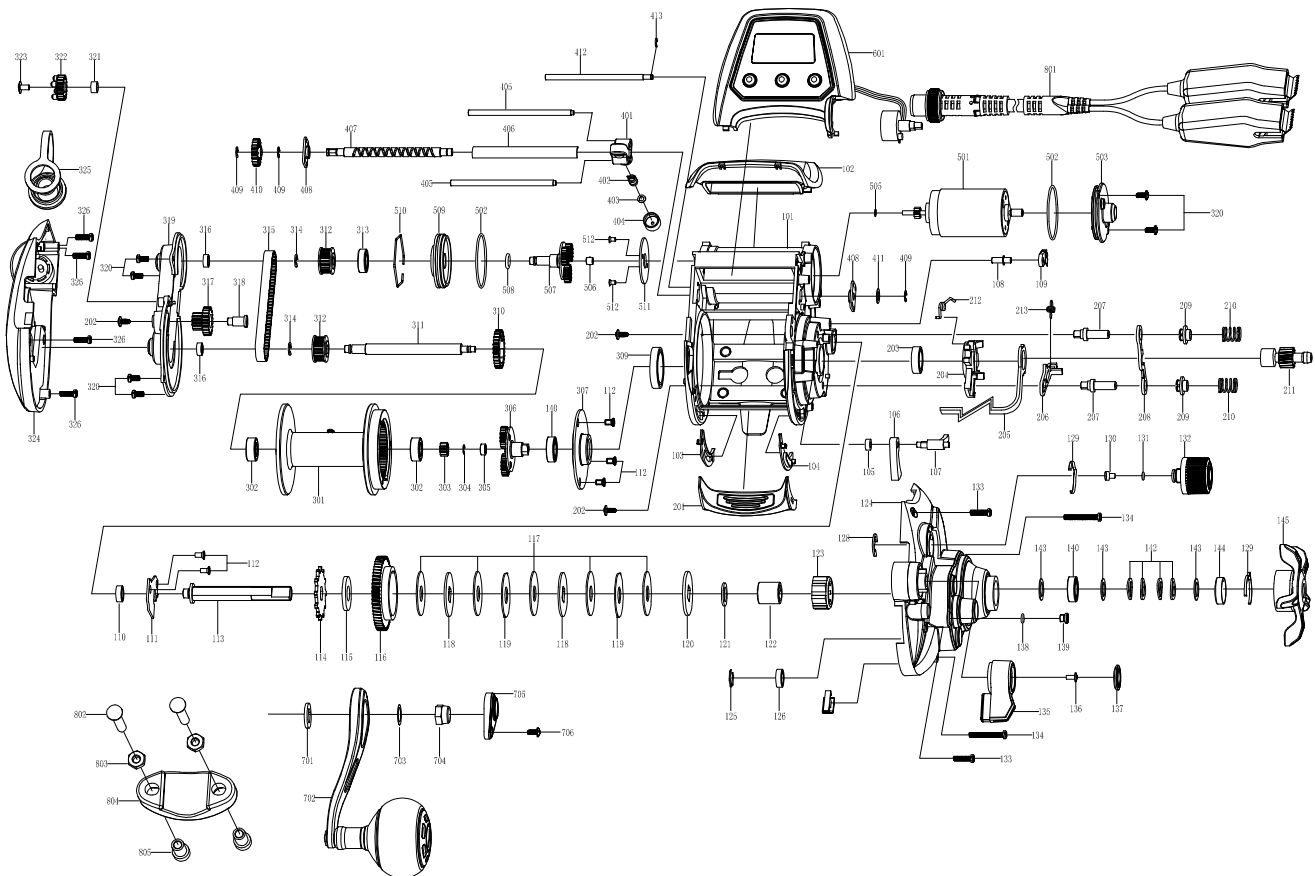


XVI. Causes and Solutions of Faults

Faults	Reason	Solution
Display does not work	Battery voltage is very low	Replace battery or charge
	Reverse connection of positive and negative electrodes of battery	Battery positive and negative electrode exchange
	Poor connection of power socket	Replace power socket
	Break of power cord	Replace power cord
Crash: Press key no response, show solidification	Circuit board failure	Unplug the power supply, and then power up and reset the LCD after it disappears.
Sudden power failure in use	The power cord is detached from the battery or electric reel.	Reconnect the power cord
	Battery voltage too low	Replace battery or charge
Drive the speed control switch, the motor does not react	The adjustable speed switch is not return to that OFF position	Turn the speed control switch to the OFF position before starting the motor
	Use of unstable power on board	Replace voltage-stable power supply
	Lineout meters less than 3m	Lineout meters must be more than 3m
Push the speed control switch and the motor starts, but the liquid crystal display digit unchanged	The clutch key is not returned to the ON position	Reset clutch key

If the system fails to work properly when tested according to the above list, and if there is any failure that must be repaired, or any order problem, please entrust the distributor to deal with it

XVII.Exlosion view and name



101	Frame	121	Washer	141	Washer	301	Spool assembly	322	Sensor gear assembly	501	Motor assembly	801	Power cord
102	Front cover	122	Roller clutch inner tube	142	Saddle washer	302	Ball bearing	323	Screw	502	Motor sealing ring A	802	Screw
103	Spacer B	123	Roller clutch	143	Washer	303	Center gear	324	B Cover assembly	503	Motor Protective Cover Assembly	803	Nut
104	Spacer A	124	A cover assembly	144	Click frame	304	Split washer	325	Power socket cover	505	Washer	804	Locking plate
105	Bushing	125	Spring	145	Star drag assembly	305	Ball bearing	326	Screw	506	Inner tube	805	Cap nut
106	Reset button	126	Ball bearing			306	Secondary planetary gear assembly			507	First planetary gear assembly		
107	Reset button pin	127	Line clip	201	Clutch lever assembly	307	Spool cover	401	Line guide assembly	508	O-ring		
108	Pawl pin	128	Split washer	202	Screw	309	Ball bearing	402	Line guide pawl	509	Supporting cover		
109	Anti-reverse pawl assembly	129	Click reed	203	Ball bearing	310	Drive gear	403	Washer	510	Spring		
110	Ball bearing	130	Brake block	204	Clutch cam	311	Spool shaft	404	Pawl cap	511	Gear washer		
111	Main shaft lock plate	131	O-ring	205	Clutch lever	312	Synchronous pulley	405	Support shaft	512	Screw		
112	Screw	132	Cast control cap	206	Kick lever	313	Ball bearing	406	Stabilizer bar				
113	Main shaft	133	Screw	207	Locating pin	314	Split washer	407	Worm shaft	601	Digital display assembly		
114	Back stopper	134	Screw	208	Clutch	315	Synchronous belt	408	Worm shaft bushing				
115	Washer	135	Accel lever	209	Clutch bushing	316	Ball bearing	409	Split washer	701	Padding block		
116	Main gear	136	Screw	210	Spring	317	Duplicate gear	410	Worm shaft gear	702	Handle assembly		
117	Friction washer	137	Accel lever cover	211	Pinion gear	318	Locating shaft	411	Washer	703	Washer		
118	Keyed washer	138	O-ring	212	Clutch cam spring	319	Retaining plate	412	Shaft	704	Handle nut		
119	Eared washer	139	Screw	213	Tension spring	320	Screw	413	Split washer	705	Nut cap		
120	Keyed washer A	140	Ball bearing			321	Gear bushing			706	Screw		



ECOODA

WEIHAI ECOODA OUTDOOR PRODUCTS CO., LTD

ADDRESS: 4th Floor, No. 6 Huojusanjie,
Hi-tech Zone, Weihai, Shandong, China

TEL: 400-0631-900

FAX: 0086-631-5685998

WEBSITE: <http://www.ecooda.com>

EMAIL: ecooda@163.com